

MODEL: *B610-36-SF*

Size

Projection 6-5/8"  
Height 10"

Length:

-Overall 38"  
-Anchor Holes 36"  
-Rubber 32"  
Angle Size (2) 1/4"x3"x4"x9-1/2"  
Slot Angle Size 1/4"x3"x4"x9-1/2"  
Face Plate Size (1) 3/8"x10"x32"

Bolt Heads Are Inscribed  
"DURABLE CORP"

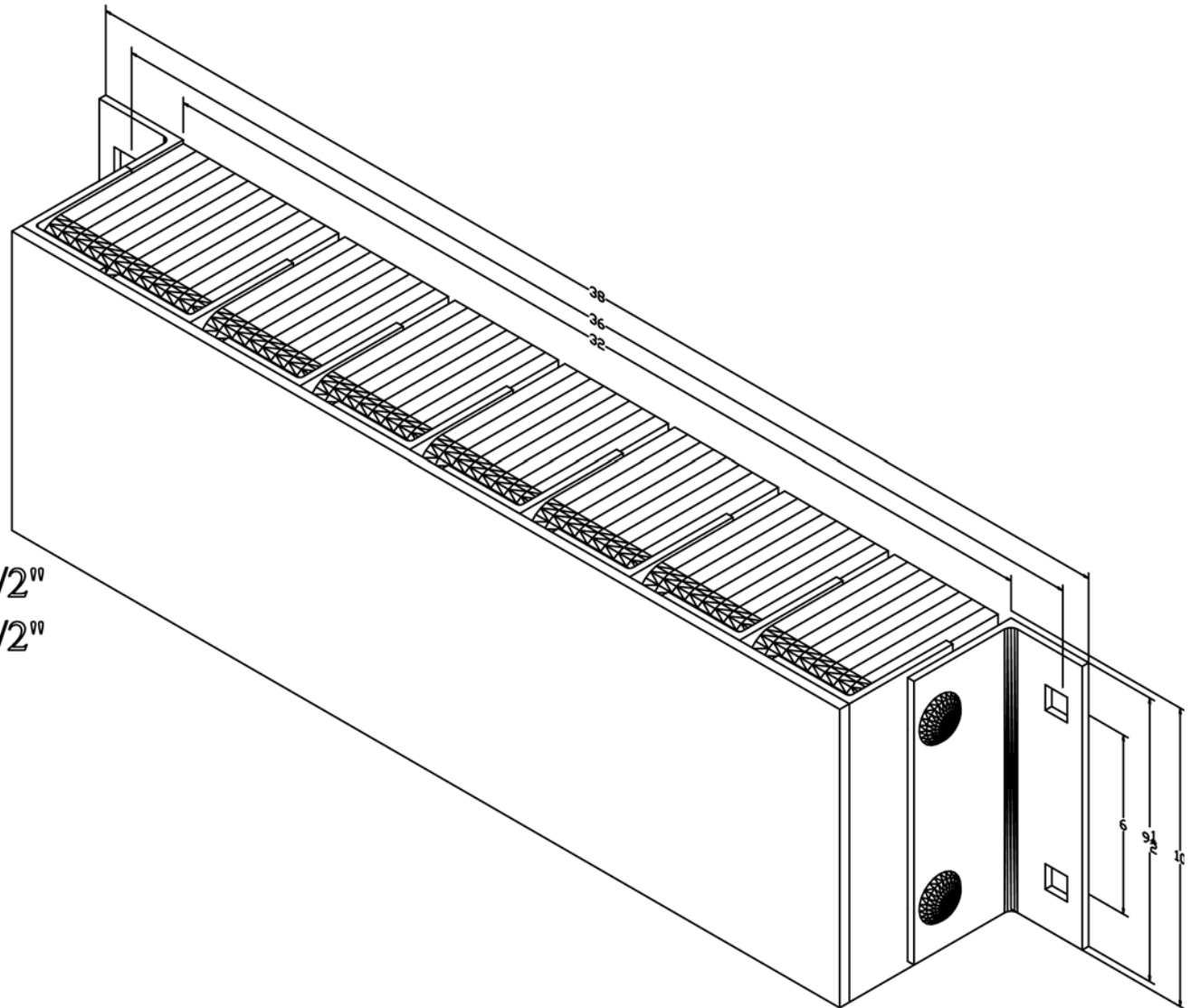

All measurements are +/- 1/8"