

MODEL: *B610-24-SF*

Size

Projection 6-5/8"
Height 10"

Length:

-Overall 26"
-Anchor Holes 24"
-Rubber 20"
Angle Size (2) 1/4"x3"x4"x9-1/2"
Slot Angle Size 1/4"x3"x4"x9-1/2"
Face Plate Size (1) 3/8"x10"x20"

Bolt Heads Are Inscribed
"DURABLE CORP"

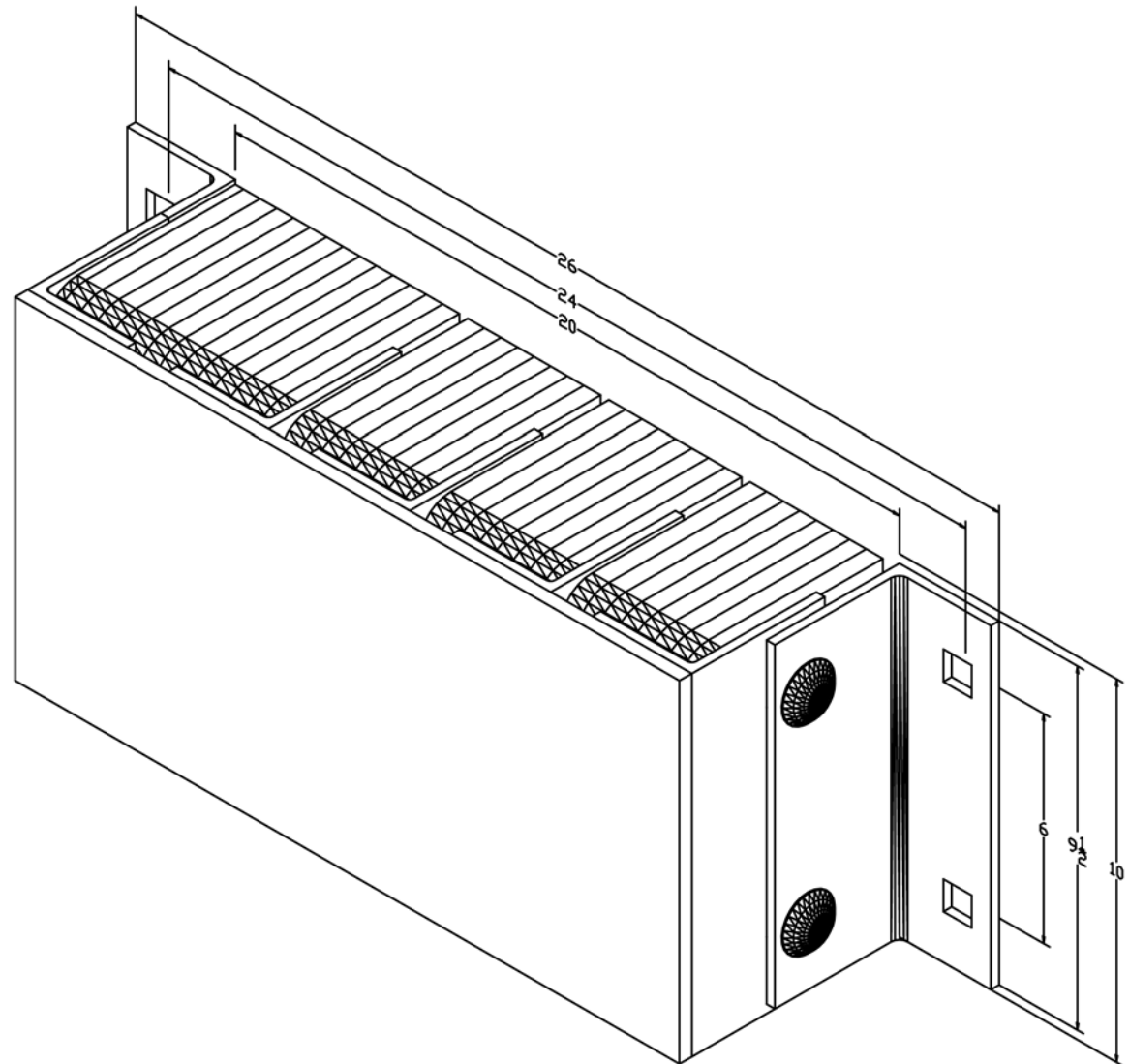

All measurements are +/- 1/8"