

MODEL: *B4512-36-SF*

Size

Projection 5-1/8"

Height 12"

Length:

-Overall 38"

-Anchor Holes 36"

-Rubber 32"

Angle Size (2) 1/4"x3"x3"x11-1/2"

Slot Angle Size 1/4"x3"x4"x11-1/2"

Face Plate Size (1) 3/8"x12"x32"

Bolt Heads Are Inscribed

"DURABLE CORP"

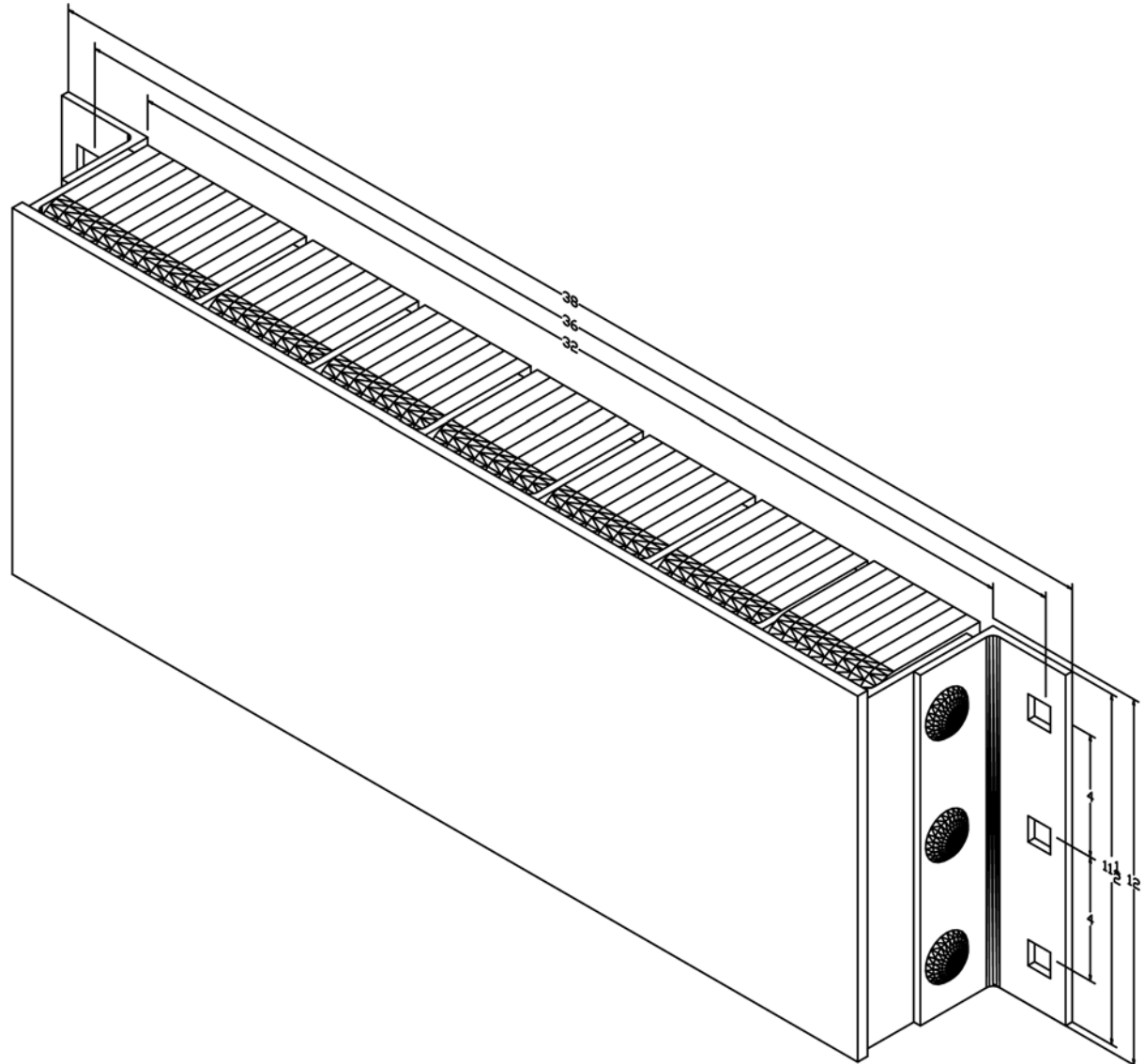

All measurements are +/- 1/8"