

MODEL: *B4512-24*

Size

Projection 4-1/2"

Height 12"

Length:

-Overall 26"

-Anchor Holes 24"

-Rubber 20"

Angle Size (2) 1/4"x3"x3"x11-1/2"

Bolt Heads Are Inscribed

"DURABLE CORP"

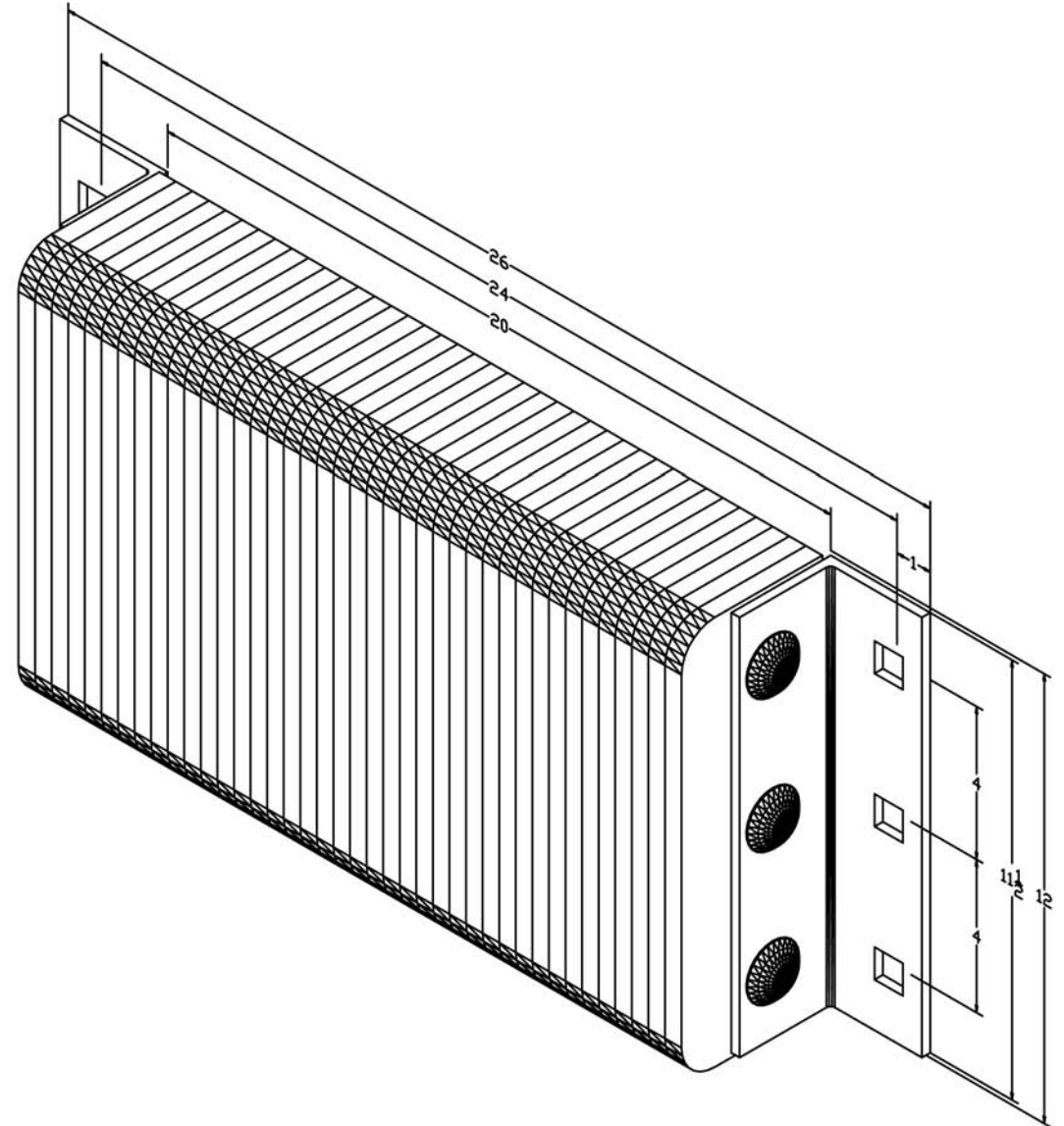

All measurements are +/- 1/8"