

MODEL: *B4512-12*

Size

Projection 4-1/2"

Height 12"

Length:

-Overall 14"

-Anchor Holes 12"

-Rubber 8"

Angle Size (2) 1/4"x3"x3"x11-1/2"

Bolt Heads Are Inscribed
"DURABLE CORP"

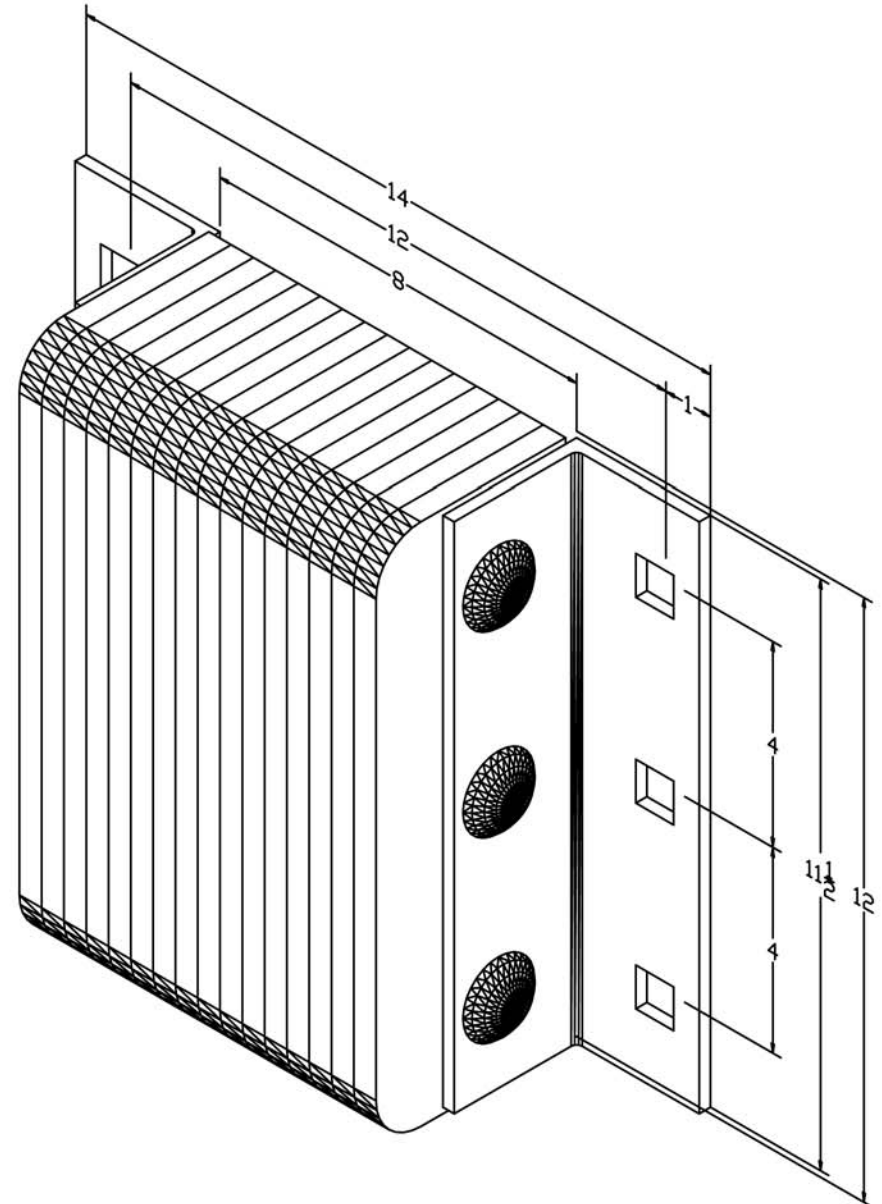

All measurements are +/- 1/8"