

MODEL: *B4506-36-SF*

Size

Projection 5-1/8"

Height 6"

Length:

-Overall 38"

-Anchor Holes 36"

-Rubber 32"

Angle Size (2) 1/4"x3"x3"x5-1/2"

Slot Angle Size 1/4"x3"x4"x5-1/2"

Face Plate Size (1) 3/8"x6"x32"

Bolt Heads Are Inscribed

"DURABLE CORP"

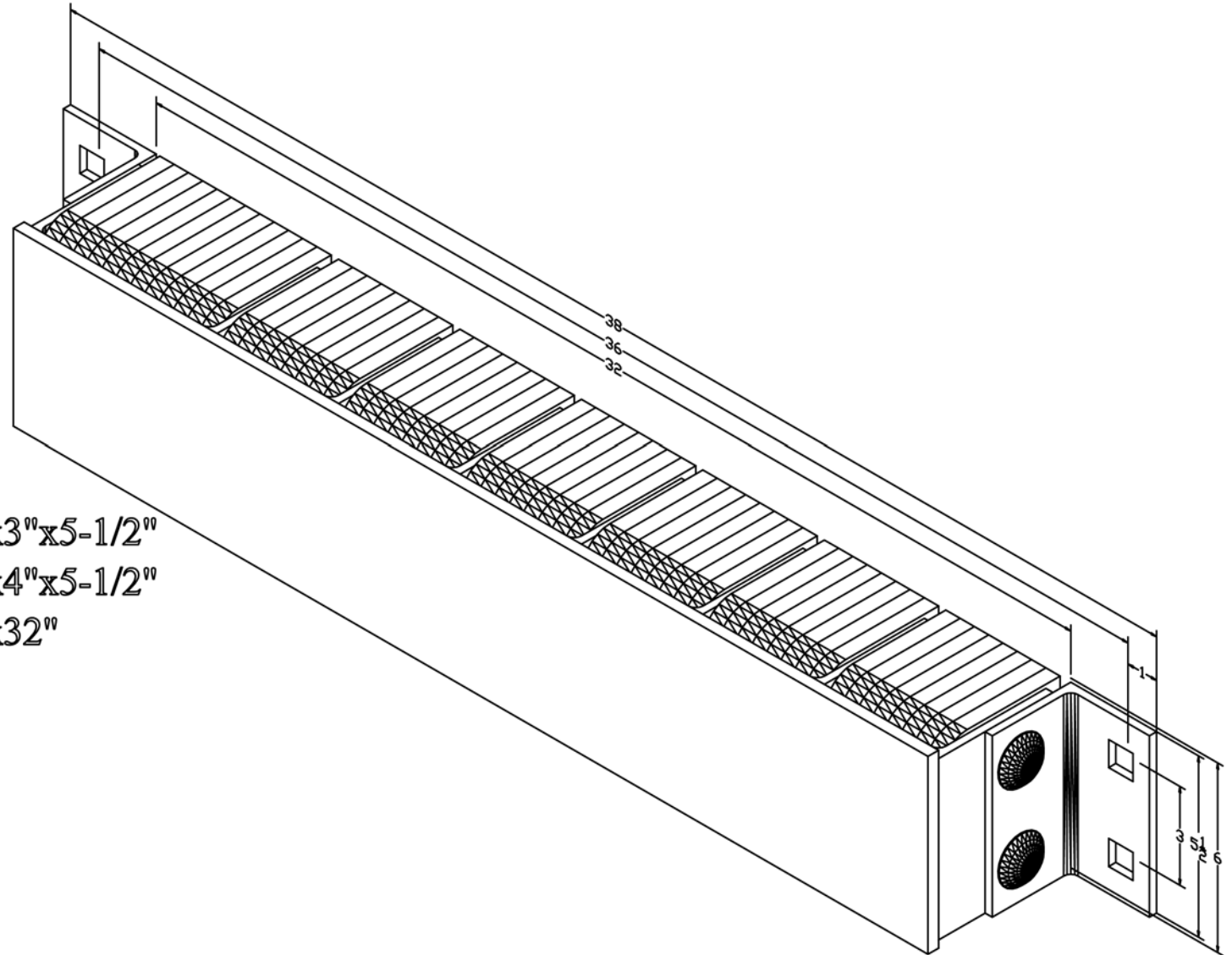

All measurements are +/- 1/8"